

SIDE BRACKETS

BRACKETS ARE FOR PERSONNEL ONLY.
Capacity 500 lbs.

All Side and End Brackets should be pinned properly in place.
Use 0068-018 Hinge Pin.

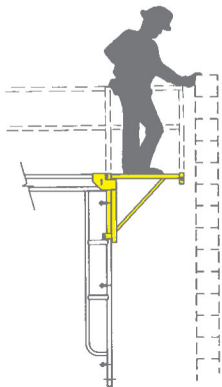
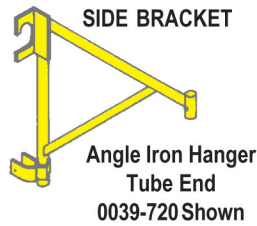
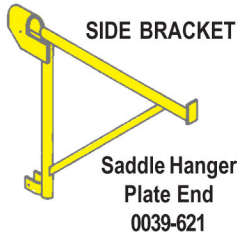
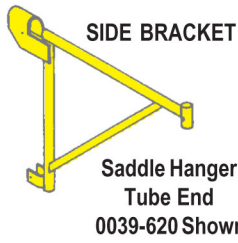

Side Bracket Shown in Application.

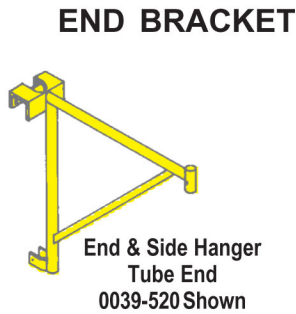

SIDE BRACKETS			
Part No. (5, 6, or 7)	Saddle Hanger/Tube End	Cap.#	Wt.#
0039-620-__	20" w/Tube End	500	9
0039-624-__	24" w/Tube End	500	10
0039-630-__	30" w/Tube End	500	13
Adj. Saddle Hanger/Tube End			
0039-165-__	20"-30" Adj. w/Tube End	500	14
Saddle Hanger/Plate End			
0039-124	12" w/Plate End	500	6
0039-621	21" w/Plate End	500	9
Angle Iron Hanger/Tube End			
0039-720-__	Side Hang-on 20"	500	9
0039-724-__	Side Hang-on 24"	500	11.5
0039-730-__	Side Hang-on 30"	500	13
END BRACKET			
Part No. (5, 6, or 7)	End & Side Hanger/Tube End	Cap.#	Wt.#
0039-520-__	End & Side Hang-on 20"	500	10.5
0039-524-__	End & Side Hang-on 24"	500	13
0039-530-__	End & Side Hang-on 30"	500	14

END GUARD RAIL FOR SIDE BRACKET

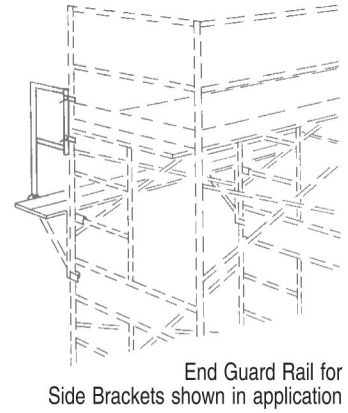
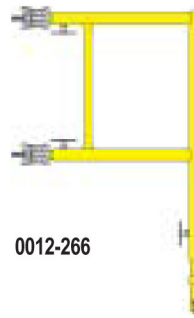

END GUARD RAIL FOR SIDE BRACKET		
Part No.	Description	Wt.#
0012-266	End Grd. Rail for 20" to 30" Side Brkt.	19

HOIST ARM / WELL WHEEL

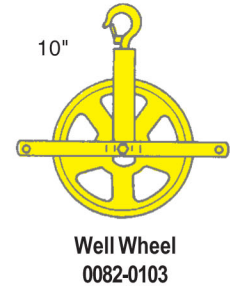
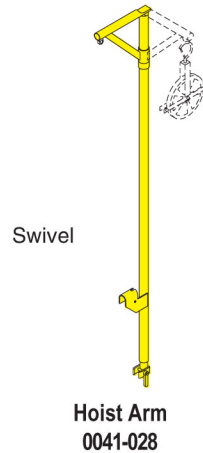

HOIST ARM / WELL WHEEL			
Part No.	Description	Capacity	Wt.#
0041-028	Swivel Head Hoist Arm	100*	29
0082-0103	10" Well Wheel	200*	13.5

*Rated to lift 100 lb. load using well wheel and rope.

SCAFFOLD TIE BRACE

0063-0344

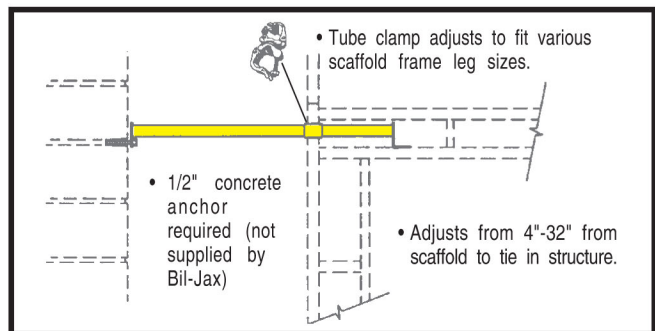

SCAFFOLD TIE BRACE		
Part No.	Description	Wt.#
0063-0344	Scaffold Tie Brace	11

PUTLOGS

Low cost method for providing larger platforms or bridging large areas or obstructions.

Only to be used for **light duty** applications. Consult engineering department for specific load ratings.



Putlog - 8', 10', 12'

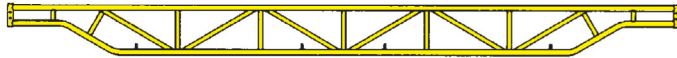

Trussed Putlog - 14'--26'

PUTLOGS

Part No.	Description	Cap.# per Linear ft.*	Total Uniform Load	Wt.#
0036-178	8' Putlog	175	1,400	24
0036-180	10' Putlog	130	1,300	30
0036-182	12' Putlog	100	1,200	36
0036-600	14' Putlog-Trussed	225	3,150	47
0036-601	16' Putlog-Trussed	170	2,720	70
0036-602	18' Putlog-Trussed	130	2,340	79
0036-603	20' Putlog-Trussed	125	2,500	92
0036-604	22' Putlog-Trussed	100	2,200	101
0036-605	24' Putlog-Trussed	85	2,040	111
0036-606	26' Putlog-Trussed	70	1,820	118

*Requires use of putlog support at each end.

PUTLOG ACCESSORIES

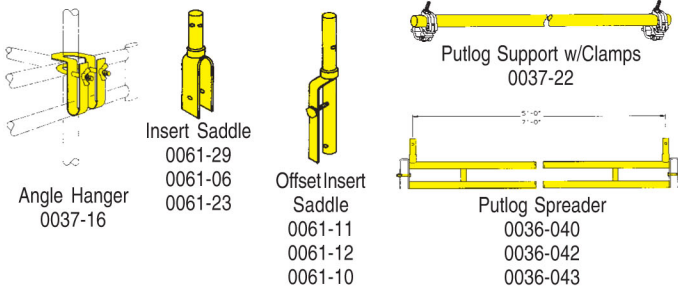

PUTLOG ACCESSORIES (5) (6) (7)

Part No.	Description	Wt.#
0037-16	Putlog Angle Hanger	3.5
0061-11	Offset Insert Saddle (Fits Tube Size 5)	3
0061-12	Offset Insert Saddle (Fits Tube Size 6)	3
0061-10	Offset Insert Saddle (Fits Tube Size 7)	3
0061-29	Insert Saddle (Fits Tube Size 5)	3
0061-06	Insert Saddle (Fits Tube Size 6)	3
0061-23	Insert Saddle (Fits Tube Size 7)	3
0037-22	Putlog Support 8' Lg. w/Clamps	20
0036-040	Putlog Spreader-5' Frame Sp. (Tube Size 6)	24
0036-042	Putlog Spreader-5' Frame Sp. (Tube Size 5)	24
0036-043	Putlog Spreader-7' Frame Sp. (Tube Size 5)	24

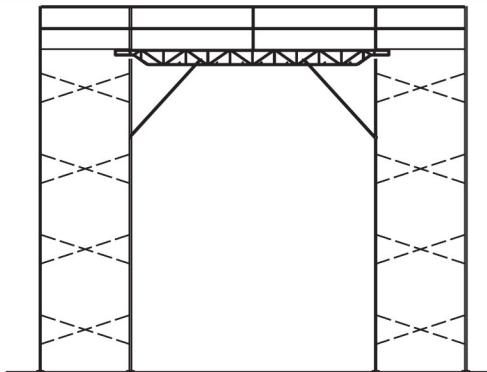

Typical Putlog Application Shown.

TUBE-N-CLAMP SCAFFOLD

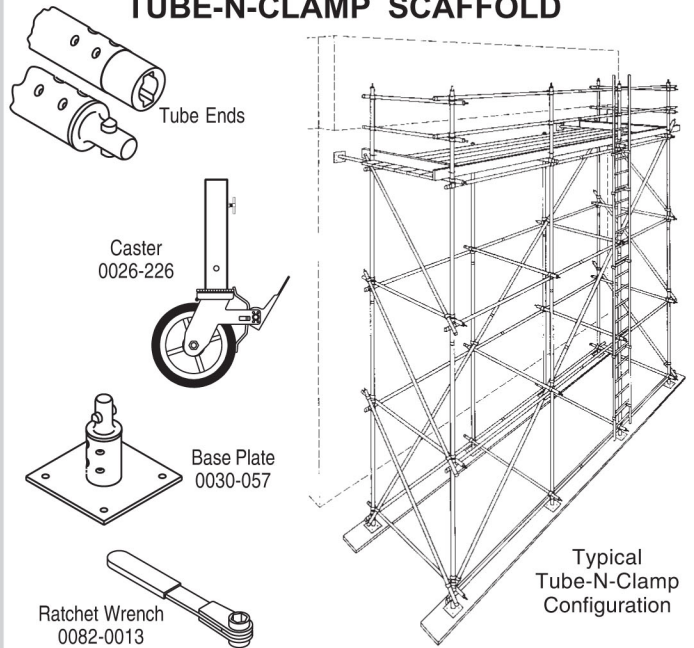

TUBE-N-CLAMP COMPONENTS

Part No.	Description	Wt.#
0076-1-04	4' Tube with Ends	9.2
0076-1-06	6' Tube with Ends	13.3
0076-1-08	8' Tube with Ends	17
0076-1-10	10' Tube with Ends	20.5
0076-1-12	12' Tube with Ends	22
0076-1-13	13' Tube with Ends	25.5
0076-1-14	14' Tube with Ends	30
0076-1-16	16' Tube with Ends	30.3
0076-1-20	20' Tube with Ends	43.5
0026-226	8" Caster	15
0030-057	Quick-Lok Base Plate	6

WRENCHES

Part No.	Description	Wt.#
0082-0053	Swing Over Wrench for 7/8" Nut	2
0082-0013	Ratchet Wrench	2

Use Drop Forged Clamps listed below for Tube-N-Clamp installations.

DROP FORGED CLAMPS WITH "T" BOLT



90° Rigid Clamp



360° Swivel Clamp

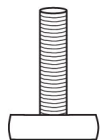

"T" Bolt Type

CLAMP w/"T" BOLT - FITS 1.5" TUBE DIAMETER

Part No.	Description	Wt.#
0069-0080	Rigid Clamp-"T" Bolt, Fits 1.5" OD Tube	2.25
0069-0081	Swiv. Clamp-"T" Bolt, Fits 1.5" OD Tube	2.25

CLAMP w/"T" BOLT - FITS 1.69" & 1.9" TUBE DIAMETER

Part No.	Description	Wt.#
0069-0082	Rigid Clamp-"T" Bolt, 1.69"&1.9" OD Tube	2.5
0069-0083	Swiv. Clamp-"T" Bolt, 1.69"&1.9" OD Tube	2.5

BRACKETS & CLAMPS

All clamps must be used with lock stud to inside of frame.

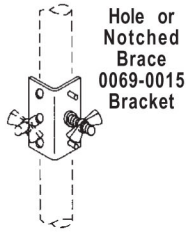

Hole or Notched Brace Bracket
0069-0015

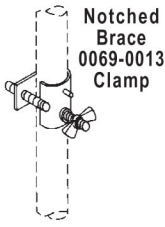

Notched Brace Clamp
0069-0013

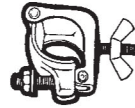

B-Lock Clamp
0069-0070
0069-0057

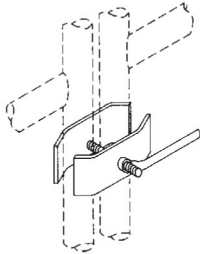

Parallel Tube Clamp
0069-0017

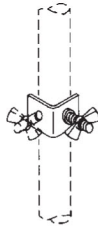

Hole Brace Bracket
0069-0026

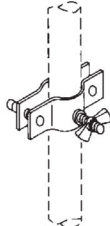

Hole Brace Clamp
0069-0043

BRACKETS & CLAMPS

Part No.	Description	Wt.#
0069-0017	Parallel Tube Clamp	1.5
0069-0015	Bracket for Hole or Notched Brace	.5
0069-0026	Bracket for Hole Brace	.5
0069-0013	Clamp for Notched Brace	1.5
0069-0043	Clamp for Hole Brace	1.5
0069-0070	Tube Size 5 B-Lock Clamp	.5
0069-0057	Tube Size 6, 7 B-Lock Clamp	.5

REPLACEMENT PARTS



0064-0783



0066-0006



0067-0005



0067-0039
0067-0046

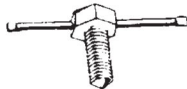

0068-004



0068-008



Brace Rivet w/Washers
0068-042/1



0068-095



0090-0517

REPLACEMENT PARTS

Part No.	Description
0064-0783	Half Outrigger Clamp
0066-0006	Putlog Clamp Hook
0067-0005	Goosier Brace Slide
0067-0039	Leveling Nut (1-7/16")
0067-0046	Leveling Nut (1-1/4")
0068-004	1/2" Set Screw
0068-008	Lever Tail Nut 5" Long - 1/2" Dia.
0068-042/1	Brace Rivet with 3 Washers
0068-042/50	Package of 50 Brace Rivets & 150 Washers
0068-095	U-Bolt Only for Angle Hanger
0090-0517	Thumb Screw - 3/8" Dia. x 1-1/4"L

All photos and drawings are for illustration only. Always concerned with the improvement of the quality of this product, the manufacturer reserves the right to modify specifications without prior notice. Follow all applicable ANSI and OSHA Codes and Regulations for the use of this equipment. Do not use this product in areas where user can come in contact with live power.



Los Angeles Office/Warehouse
www.sunsetladder.com

4421 Fountain Avenue
Los Angeles, CA 90029

(800) 794-1112
(323) 467-1190

Fax: (323) 665-0952

DROP FORGED CLAMPS WITH "EYE" BOLT

Fits all scaffold frames from 1.625" to 1.9"



90° Rigid Clamp
0069-0094
0069-0117



360° Swivel Clamp
0069-0095
0069-0118

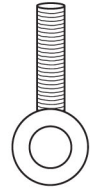

"Eye" Bolt Type

CLAMP w/"EYE" BOLT - FITS 1.625", 1.69" & 1.9" TUBE DIA.

Part No.	Description	Wt.#
0069-0094	Rigid Clamp - "Eye" Bolt, 1.625", 1.69", 1.9" OD Tube	3
0069-0095	Swiv. Clamp - "Eye" Bolt, 1.625", 1.69", 1.9" OD Tube	3
0069-0117	Rigid Clamp - "Eye" Bolt, 1.69", 1.9" OD Tube	3
0069-0118	Swiv. Clamp - "Eye" Bolt, 1.69", 1.9" OD Tube	3

LIGHT DUTY SCAFFOLDING

(Limited Applications - Consult Factory)

IMPORTANT NOTICE - NOT COMPATIBLE

Light Duty scaffolds and components are NOT compatible for use with scaffolds other than Bil-Jax Light Duty as illustrated in this section.

Follow local, state and federal codes, rules, laws, regulations and procedures on safe use of this equipment.

Not recommended to be used over 24' high.

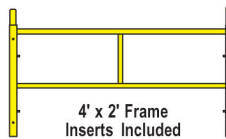

4' x 2' Frame Inserts Included
3-1242__



5" Caster
0326-830



8" Caster
0326-932



Base Plate
0030-113



4' x 4' Frame Inserts Included
3-0244__



Jack
0032-052



Extension w/Retainer
0034-053



Outrigger
0048-23

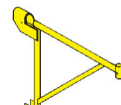

Side Bracket
0039-071
0039-093

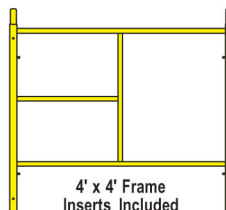

4' x 6' Frame Inserts Included
3-0246__

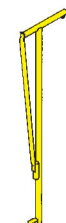

Hoist Arm
0041-17

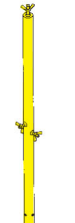

Guard Rail Post
0023-323



Replacement Insert
0007-064

Complete Guard Rail listing found on Pages 12 and 13. Braces found on Pages 9 and 10. Well Wheel found on Page 17. See Price List for weights and other information.

CLIMBING LADDER

Tubular Type

- Climbing ladders offer 12" step spacing for scaffold access.
- Easily attached to frames. Can be used with conventional guard railing, Panel Guard, or Easi-Guard.
- **NOTE:** Climbing ladders do not include support bracket. One support bracket is required per section of ladder plus one bracket to start.

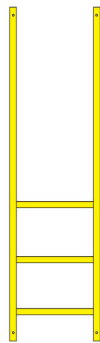

6' Top Section
0004-0377

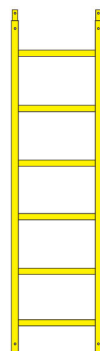

6' Ladder Section
0004-0375

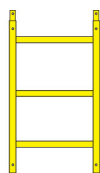

3' Ladder Section
0004-0376



Support Bracket
0063-0074
0063-0073

Typical Climbing Ladder Application Illustrated Below

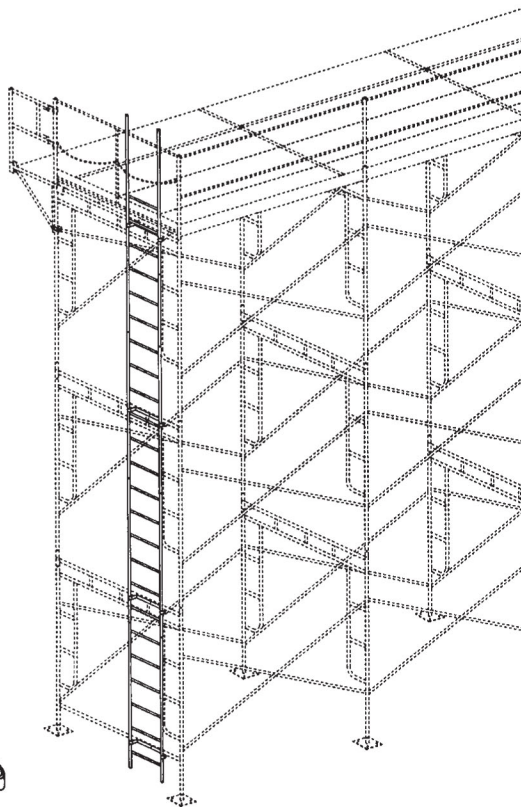

NOTE: OSHA requires landing area every 35' of height.

CLIMBING LADDER - Tubular Type*			
Part No.	Description		Wt.#
0004-0377	ST-16-T	6' Top Section	19
0004-0375	ST-16-6	6' Ladder Section	21
0004-0376	ST-16-3	3' Ladder Section	10
0063-0074	ST-16-S(5)	Support Bracket	3
0063-0073	ST-16-S(6,7)	Support Bracket	3

*Contact factory for information on channel type Climbing Ladder. Also available in galvanized finish.

All photos and drawings are for illustration only. Always concerned with the improvement of the quality of this product, the manufacturer reserves the right to modify specifications without prior notice. Follow all applicable ANSI and OSHA Codes and Regulations for use of this equipment. Do not use this product in areas where user can come in contact with live power.

ACCESS LADDER SYSTEM

- Allows worker access to platform inside on the scaffold unit.
- Can be used on rolling or stationary towers.
- Lightweight steel construction.
- Ladder hooks to frame horizontal-rests on a walk-board.
- Top hinge platform offered, allowing worker to have access through platform by hinging it out of the way. Platform hinges back into position to offer a full working deck.

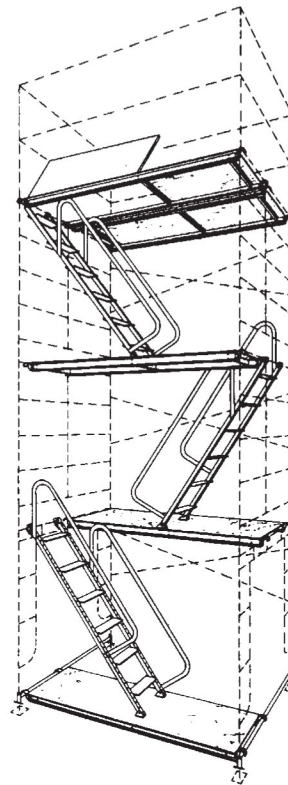

DESIGNED TO FIT IN 6' TO 6'6" HIGH FRAMES. IF USING OPEN TYPE FRAMES, END GUARD RAILING MUST BE INSTALLED.

NOTE: SOME BRACING AND GUARD RAILING WERE OMITTED IN SCAFFOLD SET-UP SHOWN FOR ILLUSTRATION PURPOSES ONLY. CONSULT FACTORY FOR NECESSARY COMPONENTS REQUIRED TO MEET SAFETY CODES AND REGULATIONS FOR THIS SET-UP.

ACCESS LADDER SYSTEM COMPONENTS

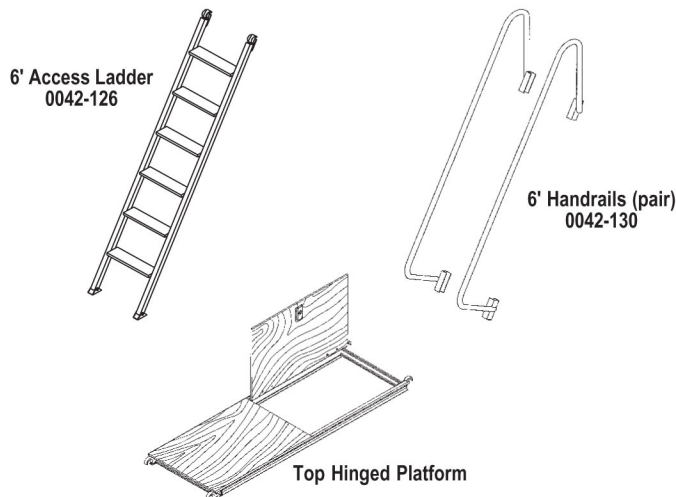

ACCESS LADDER SYSTEM			
Part No.	Description		Wt.#
0042-126	ST-130-6	6' Access Ladder -(Use w/6"6"H fr.)	37
0042-130	ST-132-6	6' Handrails (Pair)	10.5
0042-129	ST-126-B(5)	Tube Size 5 Platform Rest (2 required at first tier only)	7.5
0042-128	ST-126-B(6,7)	Tube Size 6, 7 Platform Rest (2 required at first tier only)	8
0054-346	OD-8628-07-TH	Top Hinged Platform 28" x 7'	43
0054-348	OD-8628-08-TH	Top Hinged Platform 28" x 8'	49
0054-350	OD-8628-10-TH	Top Hinged Platform 28" x 10'	55



STAIR TOWERS FOR INTERMITTENT USE

Bil-Jax offers a heavy duty stair tower for worker access to buildings, bridges, observation towers, or renovation done inside or outside. The stairs can also be used for access in a scaffold set-up.

Stair Tower Packages include frames, braces, leveling jacks, stair sections with handrails, stair rests, full top platform and top panel guard.

NOTE: Tie-ins not included in Stair Tower Packages. See Page 17 to order Scaffold Tie Braces.

FOR APPLICATIONS UP TO 100'.

Each tower package contains a top section with guard railing and a bottom section, totaling 13' in height. To figure center units needed, subtract 13' from the total height of the tower and divide the balance by 6.5.

HANDRAILS AND DIAGONAL BRACING MUST BE USED IN STAIR TOWERS. HANDRAILS AND SOME BRACING HAVE BEEN OMITTED IN THIS ILLUSTRATION FOR CLARITY.

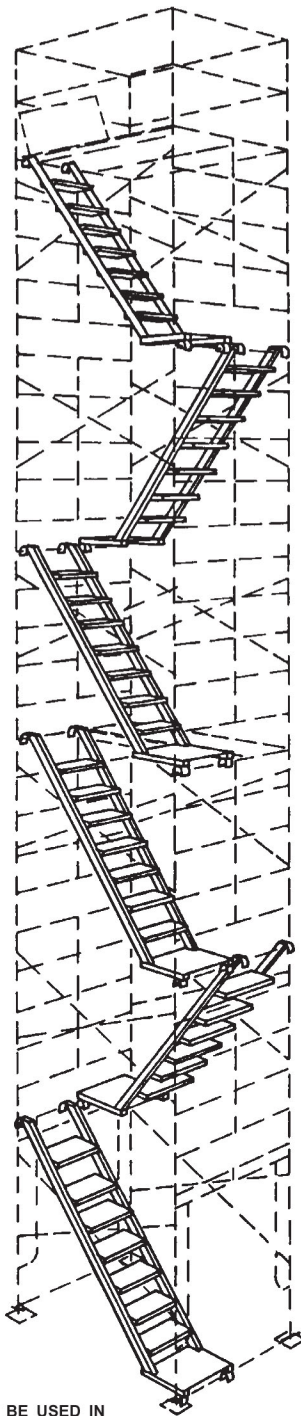

STAIR TOWER COMPONENTS

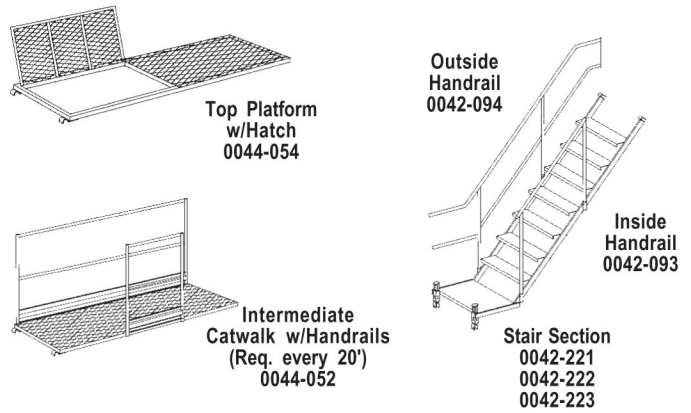

COMPONENTS		
Part No.	Description	Wt.#
0042-019	Tube Size 5 Stair Platform Rest	7
0042-027	Tube Size 6 Stair Platform Rest	8
0042-035	Tube Size 7 Stair Platform Rest	8.5
0042-047	Open Frame Safety Guard	5
0042-094	Outside Handrail	28
0042-093	Inside Handrail	15
0042-185	Outside Handrail (Top Section Only)	25
0042-175	Inside Handrail (Top Section Only)	14
0042-221	24" Width Stair Section 6'5"	74
0042-222	24" Width Stair Section 6'6"	74
0042-223	24" Width Stair Section 6'7"	74
0044-052	Intermediate Catwalk 28"W x 7' w/ Guard Rail	91
0044-054	Hinged Platform 28"W x 7' Exp. Steel	60
0044-235	28"W x 7' Exp. Steel Catwalk - 75 psf Capacity	56

HINGED LADDER BOARD

FEATURING:

- 28" Wide hinged platform (aluminum frame with plywood deck) in 7' and 10' lengths.
- Aluminum ladder attached to platform folds down providing an access ladder.
- Ladder stores under platform, out of the way when not in use.
- Requires frames that are 6' to 6'6" high.

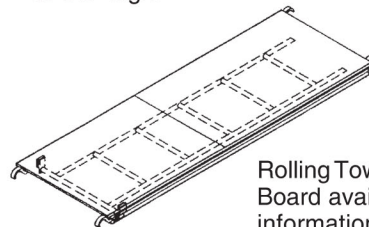
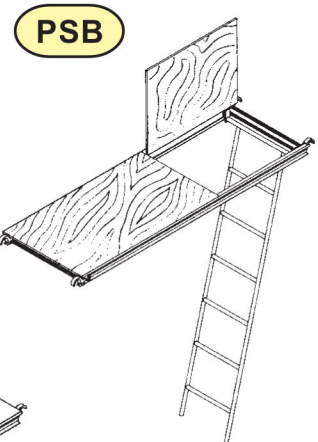

Rolling Tower Packages with Ladder Board available. Contact factory for information.

TUF-N-LITE HINGED W/ ALUM. ACCESS LADDER ATT.		
Part No.	Description	Wt.#
0054-125-07	28"Wx7'L Top Hinged - 75 psf Capacity	69
0054-125-10	28"Wx10'L Top Hinged - 50 psf Capacity	81

STAIR TOWERS FOR INTERMITTENT USE UP TO 100'		
Part No.	Description	Wt.#
ST-260-64S-(7)	13' Stair Tower Unit Package (Includes Top and Base Sections)	978
ST-260-64C-(7)	6'5" Stair Tower Unit Package (Center Section Only)	342
ST-260-66S-(5,6)	13' Stair Tower Unit Package (Includes Top and Base Sections)	974
ST-260-66C-(5,6)	6'7" Stair Tower Unit Package (Center Section Only)	344
Safety requirements call for an intermediate catwalk platform every 3rd section (20') of stair tower height.		



Los Angeles Office/Warehouse
www.sunsetladder.com

4421 Fountain Avenue
Los Angeles, CA 90029

(800) 794-1112
(323) 467-1190

Fax: (323) 665-0952

Stair Towers

ACCESS
LADDER EQUIP.

Hinged Board